

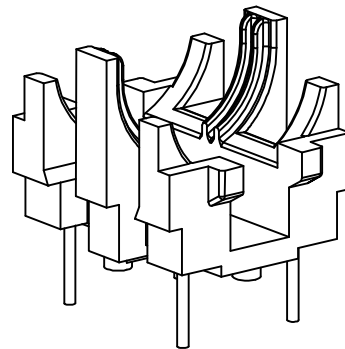

Build up your trust

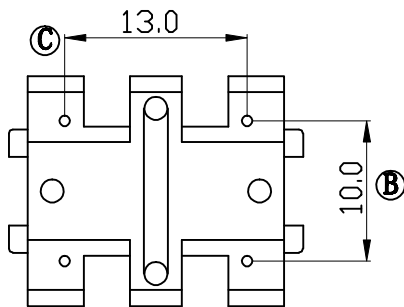
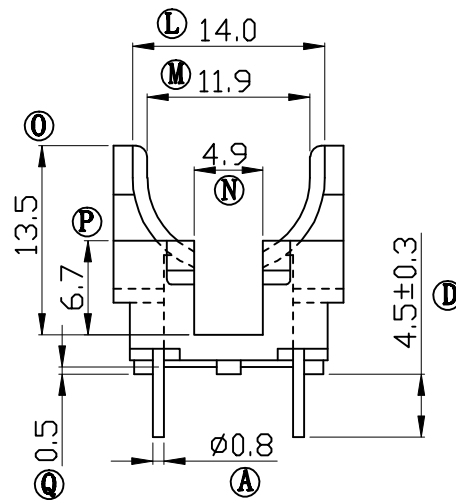
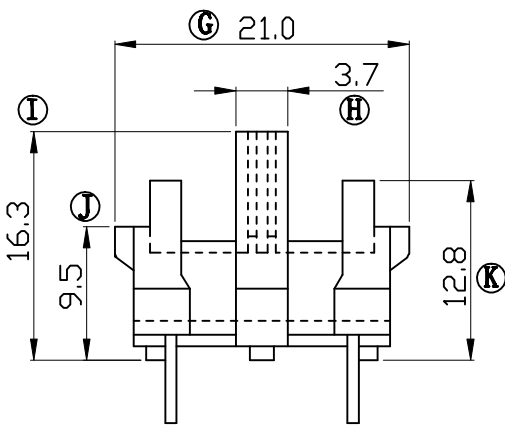
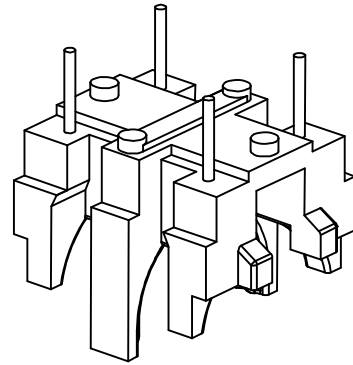
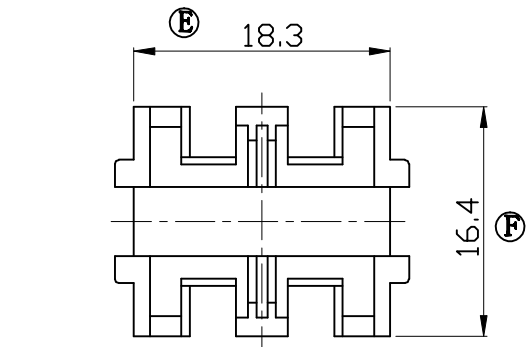

TITLE:	UT-20 4PIN		TOLERANCES	BOBBIN MATERIAL:	UL REC.
DRAWING NO:	GS-2012		0<L≤4 ±0.1 4<L≤16 ±0.2 16<L≤63 ±0.3	PHENOLIC T375HF	UL 94V-0
 建信電子制品有限公司 GEMSTONE ELECTRONIC PRODUCTS CO., LTD. ADD: 廣東省東莞市石排鎮石崇大道 TEL: (0769) 86514918, 86514919 FAX: 86514878			PIN PITCH ±0.2	PIN MATERIAL:	PIN TENSION LOAD:
				CP WIRE	1.5KG MIN
UNIT:	MM	SCALE:	2/1	ANGLE:	DATE:
				±1°	2008/10/11
		REV:			A1
		DRAWN:	XU ZHAN	CHECK:	APPROVED:
				XU ZHAN	

REV.	PORTION.	BEFORE REV.	AFTER REV.