

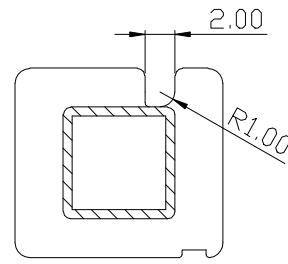

Build up your trust

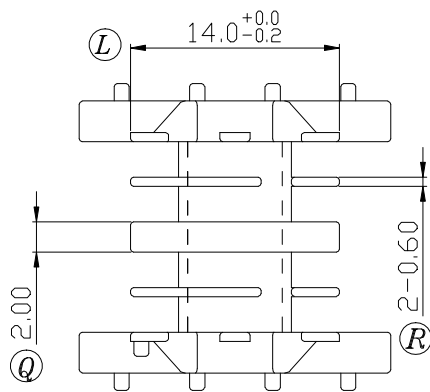

SEC. A-A

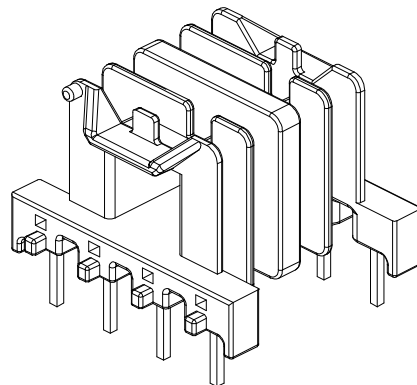
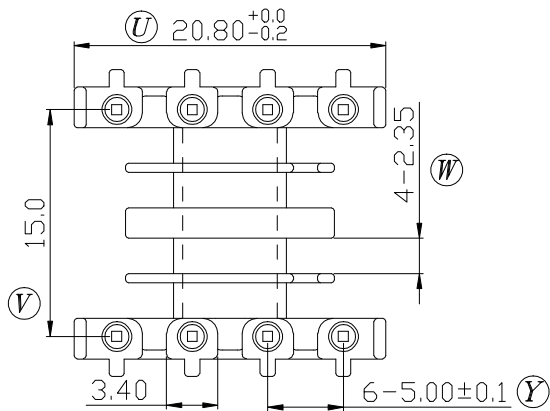
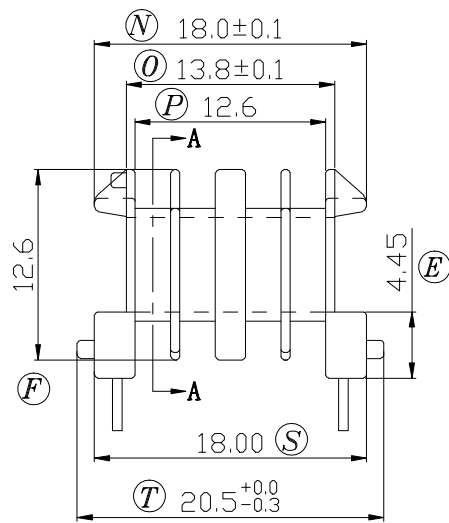
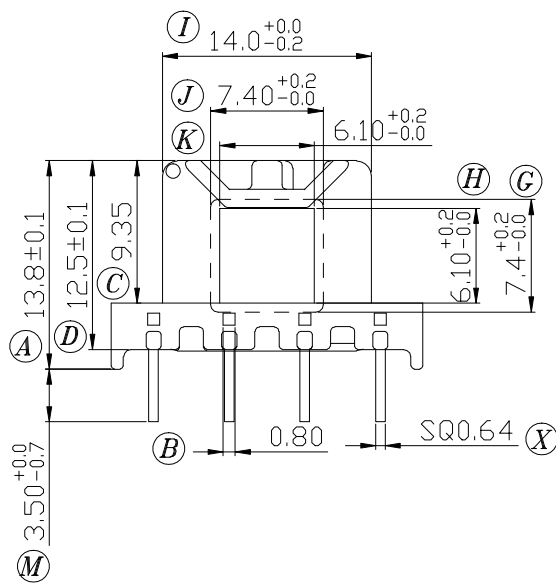

TITLE: EF-20 8PIN	TOLERANCES		BOBBIN MATERIAL: PET FR530		UL REC. UL 94V-0
DRAWING NO: GS-2017	$0 < L \leq 4 \pm 0.1$ $4 < L \leq 16 \pm 0.2$ $16 < L \leq 63 \pm 0.3$		PIN MATERIAL: CP WIRE		PIN TENSION LOAD: 1.5Kg MIN
 <b>建信電子制品有限公司</b> GEMSTONE ELECTRONIC PRODUCTS CO., LTD.	UNIT: MM	SCALE: 2/1	ANGLE: $\pm 1^\circ$	DATE: 2009/08/29	REV: A1
	DRAWN: XU ZHAN		CHECK: XU ZHAN		APPROVED:

	BEFORE REV.	AFTER REV.