

Build up your trust

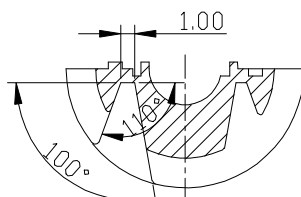

Section:D-D

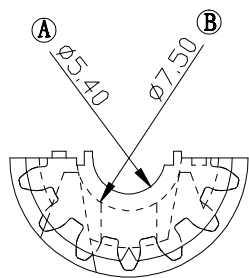
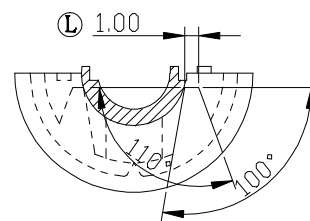

Section:A-A

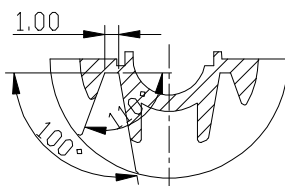
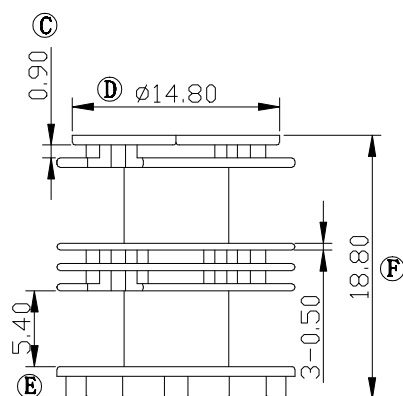

Section:C-C

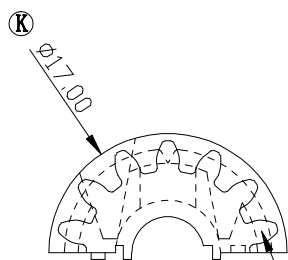
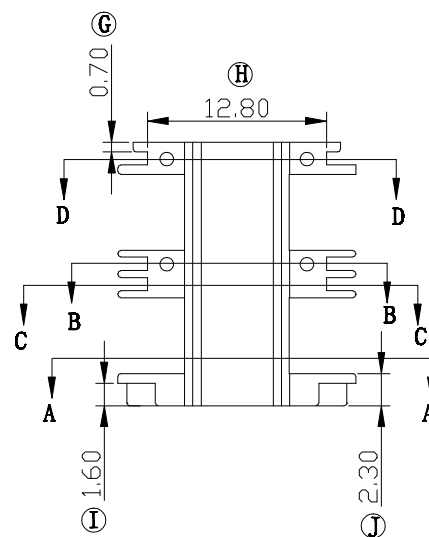

M=1
14T
O.D=ø16
P.D=ø14

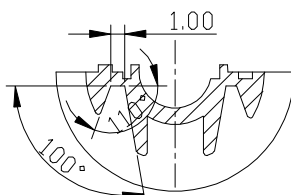

Section:B-B

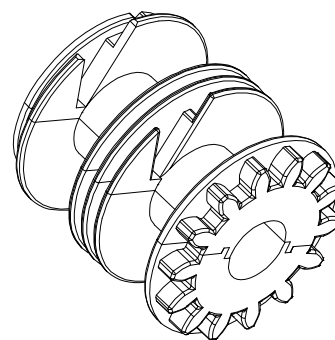

TITLE:	ET-24 轮轴	TOLERANCES		BOBBIN MATERIAL:		UL REC.	
DRAWING NO:	GS-2409	0<L≤4 ±0.1	PIN PITCH ±0.2	PBT		94V-0	
 建信電子制品有限公司 GEMSTONE ELECTRONIC PRODUCTS CO.,LTD. ADD: 廣東省東莞市石排鎮石崇大道 TEL: (0769) 86514918, 86514919 FAX: 86514878		4<L≤16 ±0.2		PIN MATERIAL:		PIN TENSION LOAD:	
		16<L≤63 ±0.3		ANGLE: ±1°		DATE: 2007/03/20	
		UNIT: MM	SCALE: 2/1	CHECK: XU ZHAN		REV: A0	
		DRAWN: Wang Ren Jun		APPROVED:			

REV.	PORTION.	BEFORE REV.	AFTER REV.