

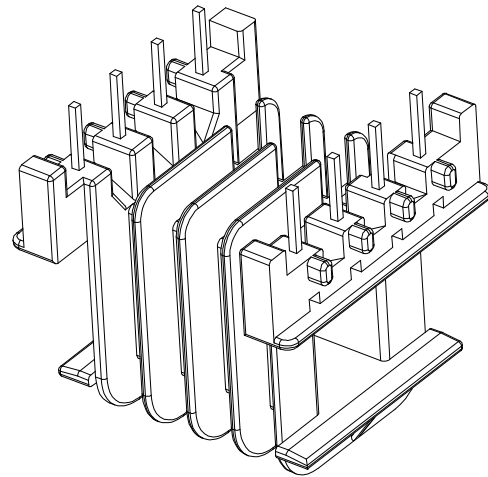

Build up your trust

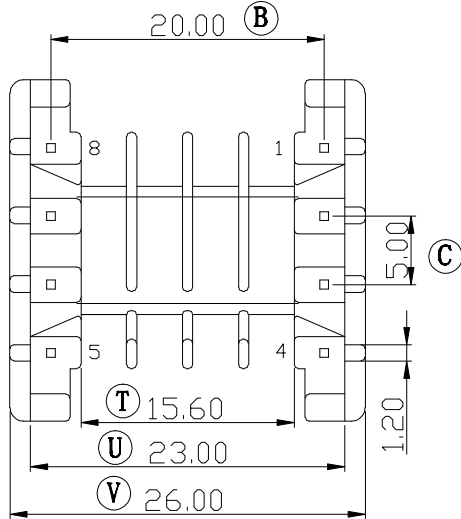
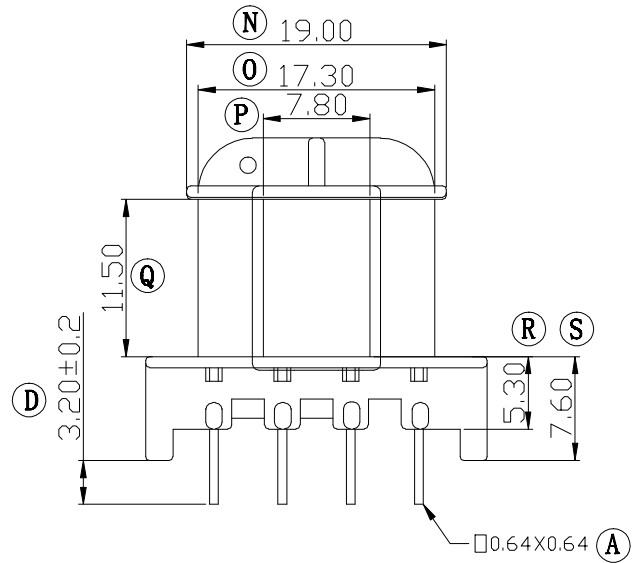
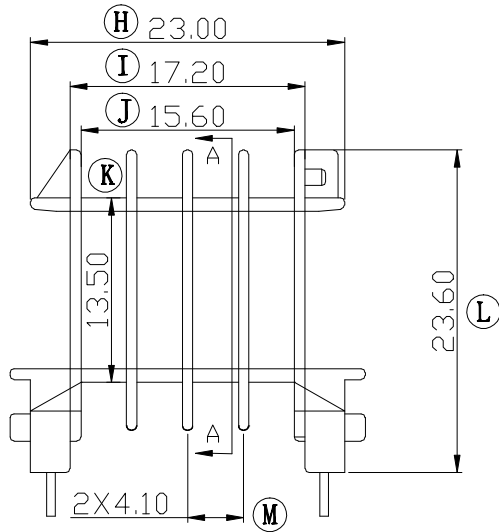
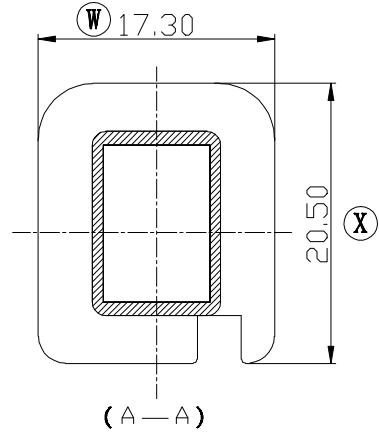
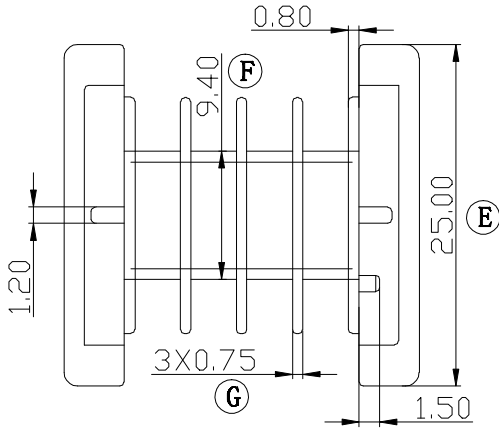

| | | | | | | | |
|--|--|---------------|-------------------|------------------------------------|--|--------------------------------|--|
| TITLE: BOBBIN EE-25/11 | | TOLERANCES | | BOBBIN MATERIAL: PET-FR530 (NC) | | UL REC. UL 94V-0 | |
| DRAWING NO: GS-2522-3 | | 0<L≤4 ±0.1 | PIN PITCH ±0.2 | PIN MATERIAL: CP WIRE | | PIN TENSION LOAD: 1.5KG MIN | |
|  建信電子制品有限公司 GEMSTONE ELECTRONIC PRODUCTS CO., LTD. ADD: 廣東省東莞市石排鎮石崇大道 TEL: (0769) 86514918, 86514919 FAX: 86514878 | | 4<L≤16 ±0.2 | | ANGLE: ±1° | | DATE: 2006/02/21 | |
| | | 16<L≤63 ±0.3 | | REV: A0 | | APPROVED: | |
| UNIT: MM | | SCALE: 2/1 | | DRAWN: HZP | | CHECK: XU ZHAN | |

| | | | |
|------|----------|-------------|------------|
| REV. | PORTION. | BEFORE REV. | AFTER REV. |
| | | | |
| | | | |
| | | | |