

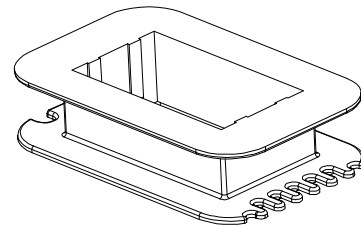

Build up your trust

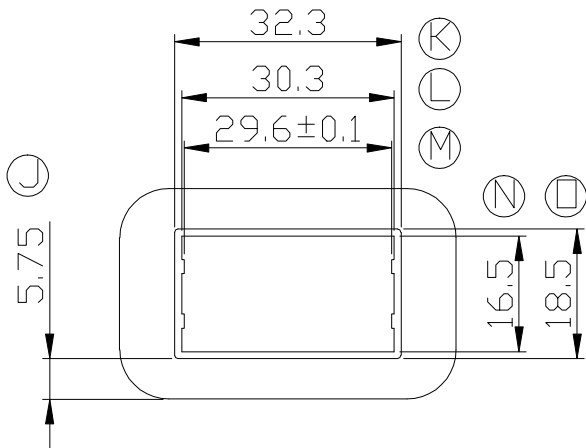
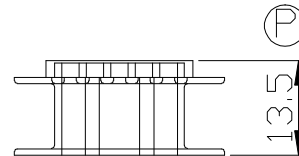
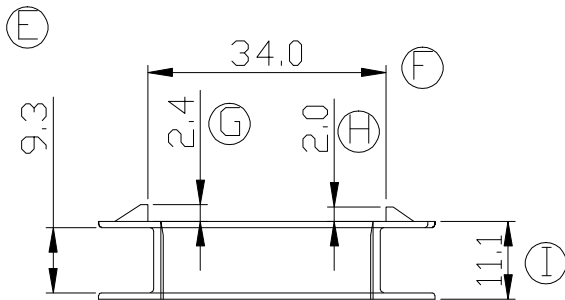
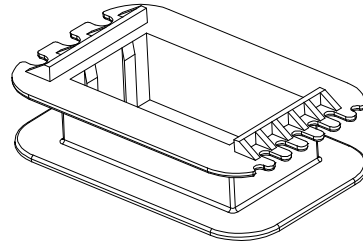
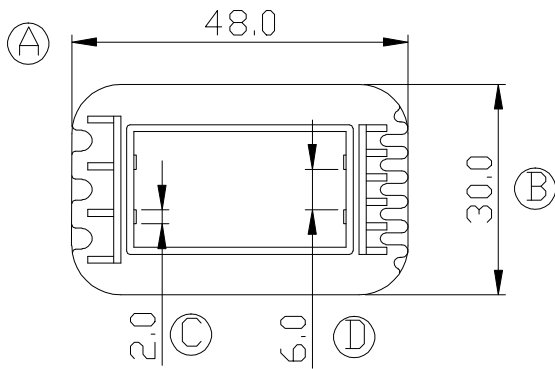

TITLE:	EI-48*30	TOLERANCES		BOBBIN MATERIAL:		UL REC.
DRAWING NO:	GS-4802	0<L≤4 ±0.1	PIN PITCH ±0.2	PA66 1300S		UL 94V-2
 建信電子制品有限公司 GEMSTONE ELECTRONIC PRODUCTS CO.,LTD.		4<L≤16 ±0.2		PIN MATERIAL:		PIN TENSION LOAD:
		16<L≤63 ±0.3				
ADD: 廣東省東莞市石排鎮石崇大道 TEL: (0769) 86514918, 86514919 FAX: 86514878		UNIT: MM	SCALE: 1/1	ANGLE: ±1°	DATE: 2004/11/2	REV: A0
		DRAWN: XU ZHAN		CHECK: DAVID		APPROVED:

REV.	PORTION.	BEFORE REV.	AFTER REV.