

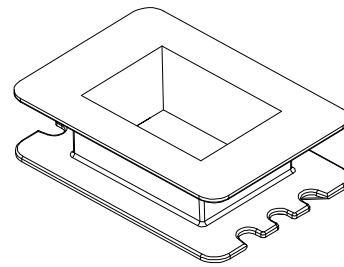

Build up your trust

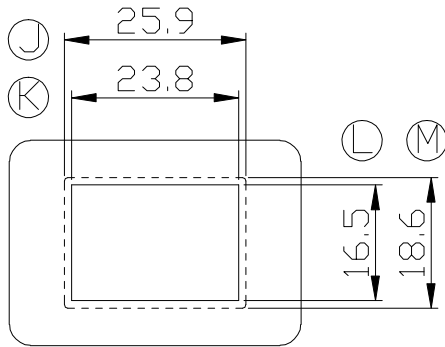
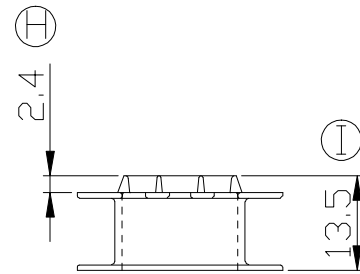
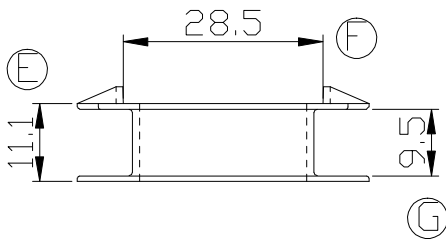
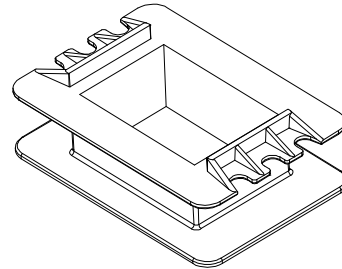
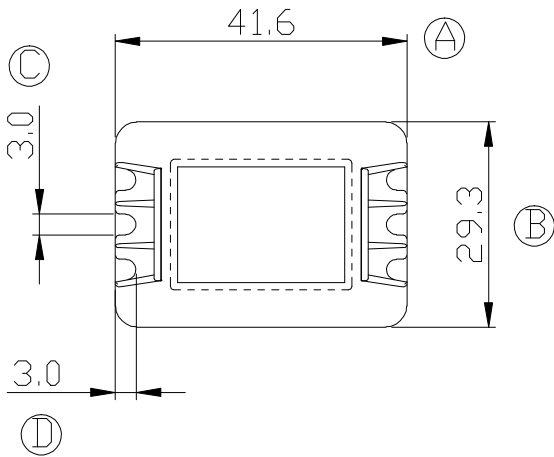

TITLE:	EI-48*24	TOLERANCES		BOBBIN MATERIAL:	UL REC.	
DRAWING NO:	GS-4803	0<L≤4 ±0.1	PIN PITCH ±0.2	PLASTIC NYLON 66	UL 94V-2	
		4<L≤16 ±0.2		PIN MATERIAL:	PIN TENSION LOAD:	
		16<L≤63 ±0.3				
 建信電子制品有限公司 GEMSTONE ELECTRONIC PRODUCTS CO., LTD. ADD: 廣東省東莞市石排鎮石崇大道 TEL: (0769) 86514918, 86514919 FAX: 86514878		UNIT:	SCALE:	ANGLE:	DATE:	
		MM	1/1	±1°	2004/12/18	REV:
		DRAWN:		CHECK:	APPROVED:	
		XU ZHAN	DAVID			

REV.	PORTION.	BEFORE REV.	AFTER REV.