

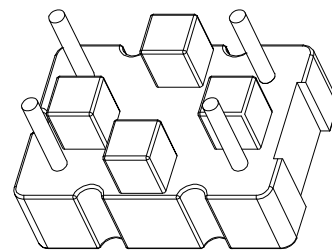

Build up your trust

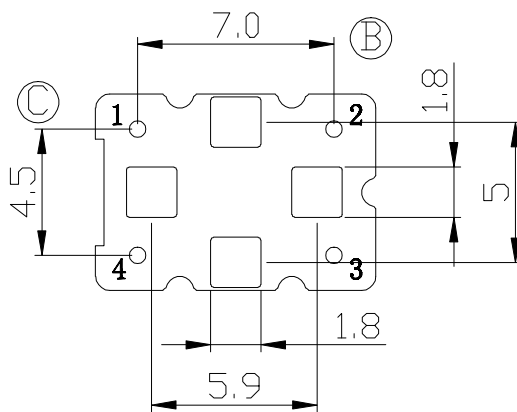
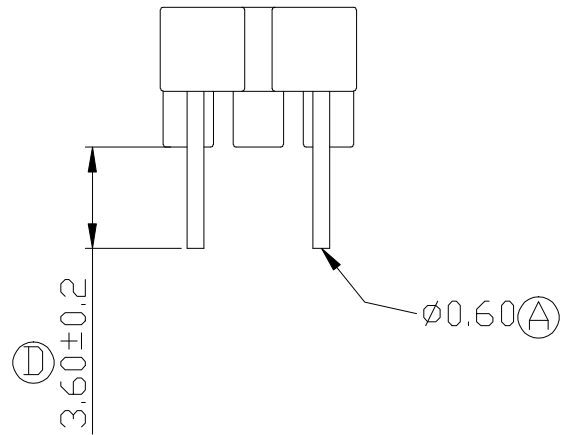
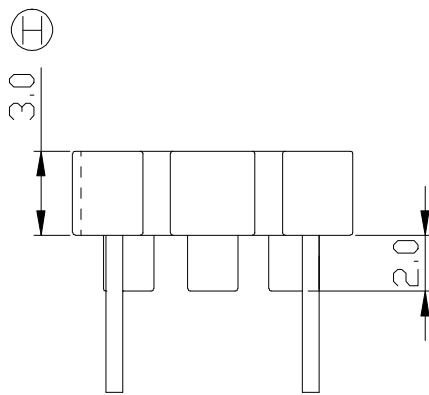
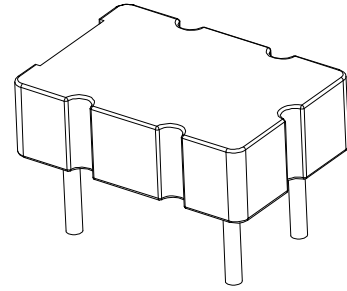
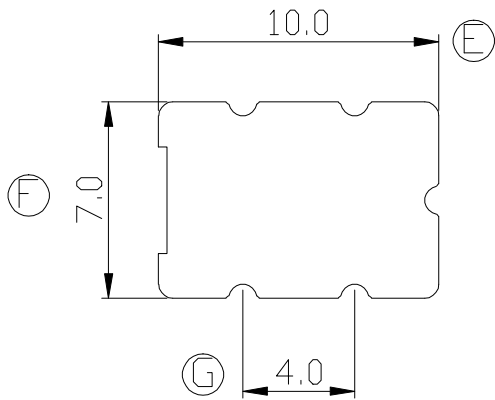

TITLE:	BASE (4PIN)	TOLERANCES		BOBBIN MATERIAL:	UL REC.
DRAWING NO:	GS-B003-2	0<L≤4 ±0.1	PIN PITCH ±0.2	PHENOLIC PM9820	UL 94V-0
 建信電子制品有限公司 GEMSTONE ELECTRONIC PRODUCTS CO.,LTD. ADD: 廣東省東莞市石排鎮石崇大道 TEL: (0769) 86514918, 86514919 FAX: 86514878		4<L≤16 ±0.2		PIN MATERIAL:	PIN TENSION LOAD:
		16<L≤63 ±0.3		CP WIRE	1.0KG MIN
		UNIT: MM	SCALE: 4/1	ANGLE: ±1°	DATE: 2012/3/13
		DRAWN: XU ZHAN		CHECK: XU ZHAN	REV: A1
				APPROVED:	

REV.	PORTION.	BEFORE REV.	AFTER REV.