

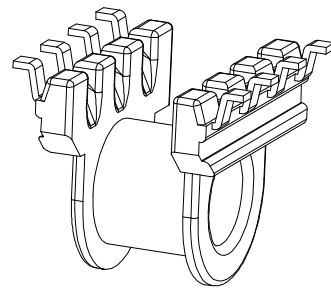

Build up your trust

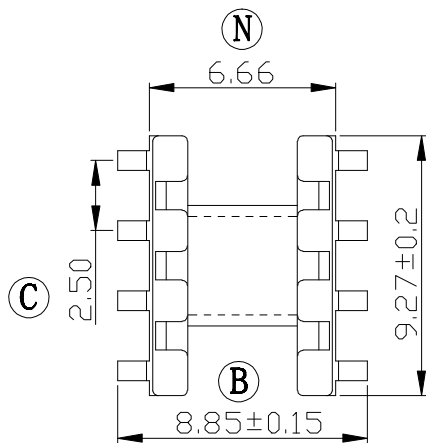
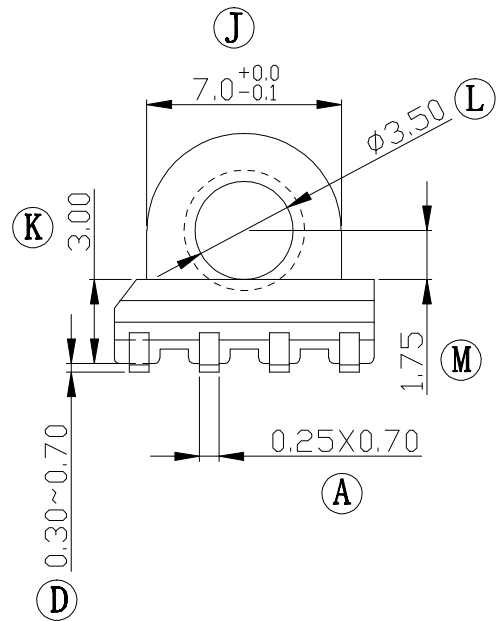
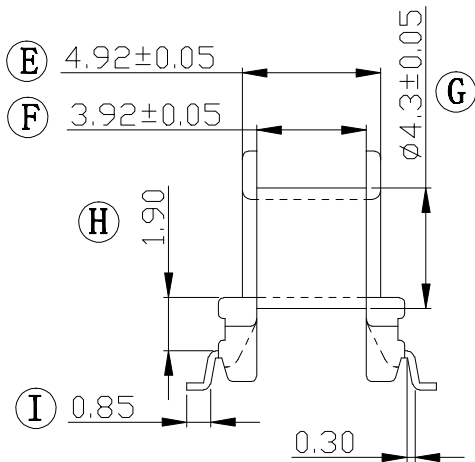
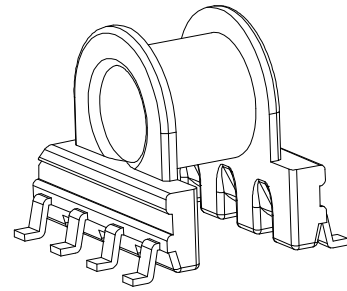
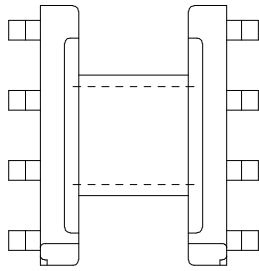

TITLE: SMD EP 7 (8PIN)	TOLERANCES		BOBBIN MATERIAL: PHENOLIC PM9630	UL REC. UL 94V-0
DRAWING NO: GS-S701-2	± 0.10		PIN MATERIAL: PHOSPHOR BRONZE	PIN TENSION LOAD: 1.0KG MIN
 建信電子制品有限公司 GEMSTONE ELECTRONIC PRODUCTS CO., LTD. ADD: 廣東省東莞市石排鎮石崇大道 TEL: (0769) 86514918, 86514919 FAX: 86514878	UNIT: MM	SCALE: 4/1	ANGLE: $\pm 1^\circ$	DATE: 2007/04/28
	DRAWN: Wang Ren Jun		CHECK: XU ZHAN	REV: A0

REV.	PORTION.	BEFORE REV.	AFTER REV.