

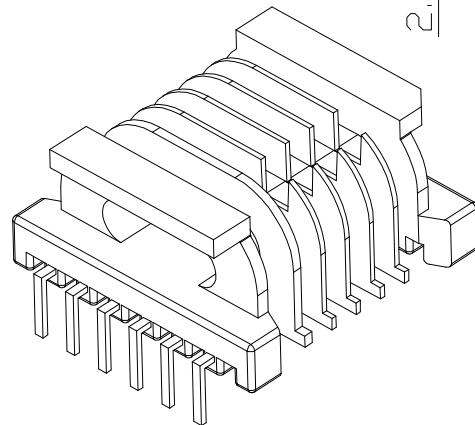

Build up your trust

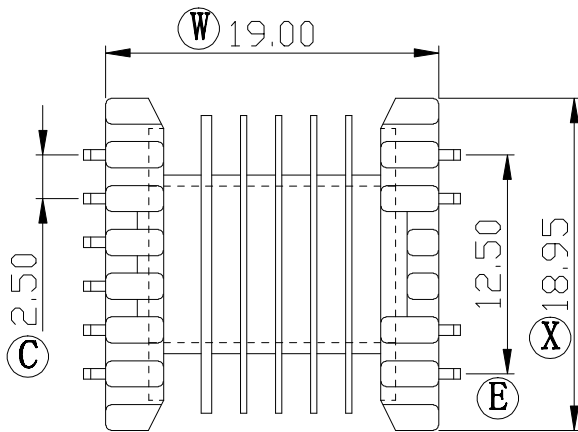
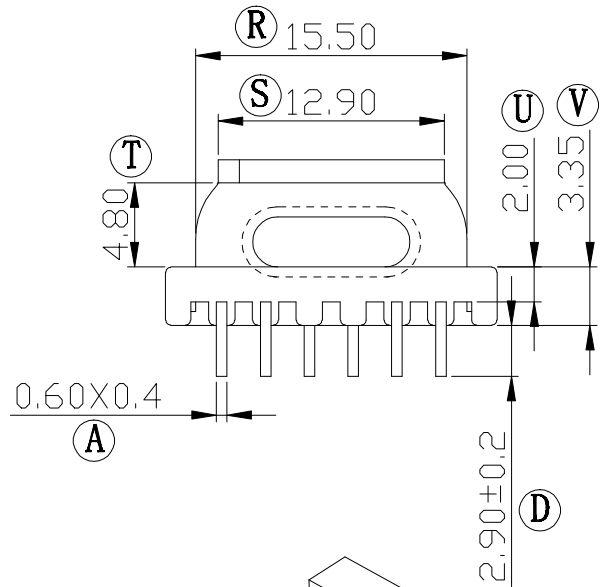
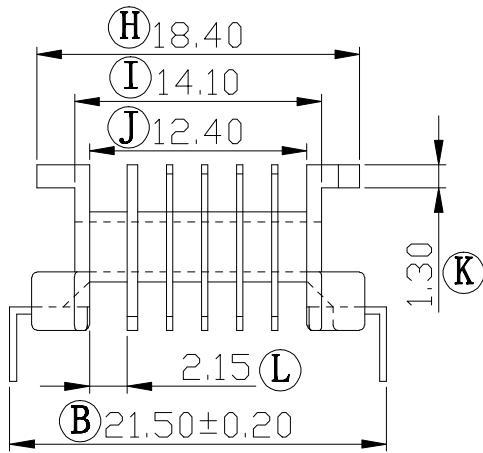
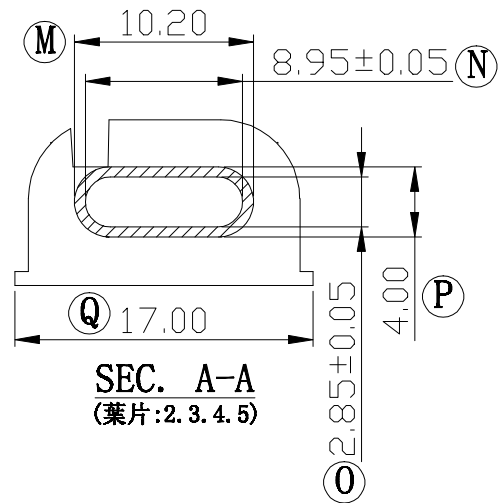
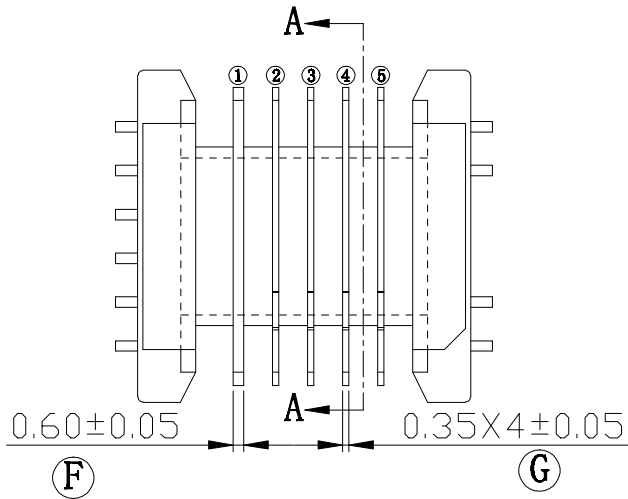

TITLE: SMD EPC-19(6 SEC)	TOLERANCES		BOBBIN MATERIAL: LCP E4008	UL REC. UL 94V-0
DRAWING NO: GS-S1901	±0.1 MM	PIN PITCH ±0.1	PIN MATERIAL: PHOSPHOR BRONZE	PIN TENSION LOAD: 1.5KG MIN
 建信電子制品有限公司 GEMSTONE ELECTRONIC PRODUCTS CO., LTD. ADD: 廣東省東莞市石排鎮石崇大道 TEL: (0769) 86514918, 86514919 FAX: 86514878	UNIT: MM	SCALE: 2.5/1	ANGLE: ±1°	DATE: 2005/12/5
	DRAWN: HZ PING		CHECK: XU ZHAN	REV: A0

REV.	PORTION.	BEFORE REV.	AFTER REV.